



*STRONG, DEPENDABLE ATTACHMENTS AND ACCESSORIES*

2/3 Atlas Court  
Welshpool  
Western Australia 6106

Telephone: (08) 9458 7933  
Facsimile: (08) 9458 1351  
ABN 67 458 625 997

## **EXTENDABLE JIB**

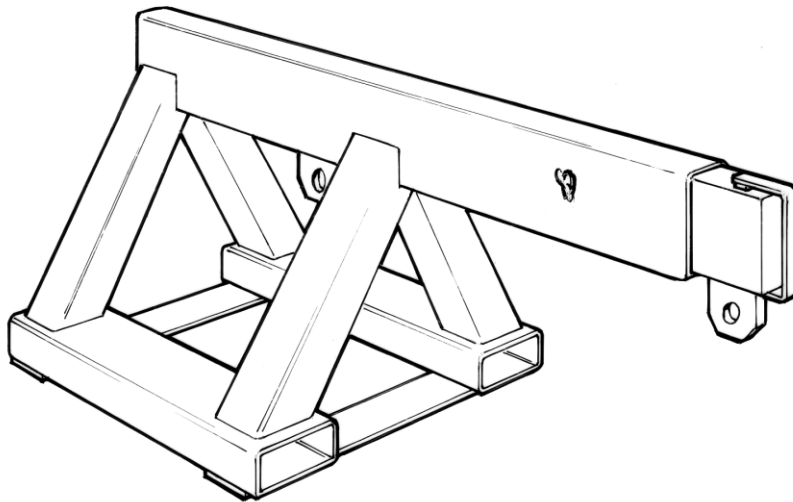

<b>Model -</b>	<b>HSEJ-75</b>
<b>Capacity -</b>	<b>7500kgs @ 600mm</b> <b>6500kgs @ 1050mm</b> <b>5000kgs @ 1450mm</b> <b>5000kgs @ 2050mm</b> <b>3750kgs @ 2400mm</b> <b>2000kgs @ 2775mm</b> <b>1150kgs @ 3150mm</b> <b>720kgs @ 3500mm</b>
<b>Unit weight -</b>	<b>350kgs</b>
<b>HCG -</b>	<b>900mm</b>
<b>Lost load -</b>	<b>0 mm</b>
<b>Paint finish -</b>	<b>Golden yellow</b>

**Supplied complete with safety swivel hook.**