



STRONG, DEPENDABLE ATTACHMENTS AND ACCESSORIES

2/3 Atlas Court
Welshpool
Western Australia 6106

Telephone: (08) 9458 7933
Facsimile: (08) 9458 1351
ABN 67 458 625 997

DRUM TIPPER HYDRAULIC

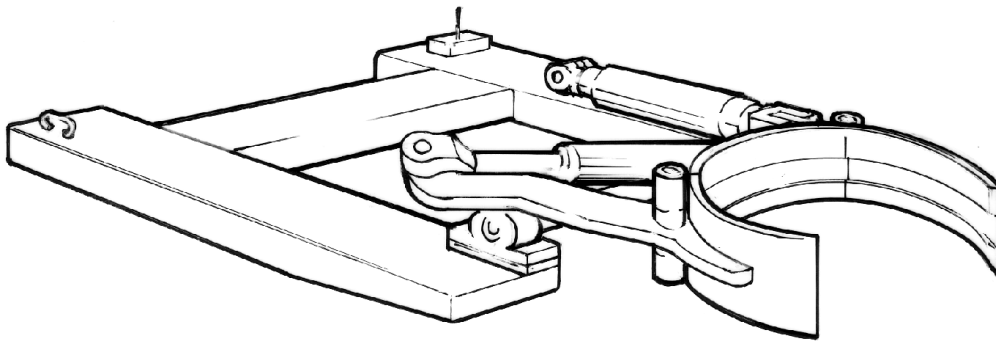

Model -	HSDT-HT500
Capacity -	500Kgs
Forward rotation -	130 degrees
Unit Weight -	150Kgs
Load Centre -	1250 mm
Pocket Size -	140 x 65mm
Pocket Centres -	820mm
HCG -	800mm

**Hydraulic grab and rotate of 205 litre drums.
Connected via quick release couplings to the
Forklifts hydraulics – Two auxiliary functions
required on forklift. Retained by safety chain.**